



**Model: HM231132/110**

Basic size of  
mm

d:	139.7
D:	236.538
T:	57.15

The basic rated load is  
kN

trends C:	512
static state Co:	850
Fatigue load limit Pu:	86.5

Rated rotation speed is  
r/min

Refer to the speed:	1900
limit speed:	2800
quality:	10
model:	HM231132/110
series:	HM231100

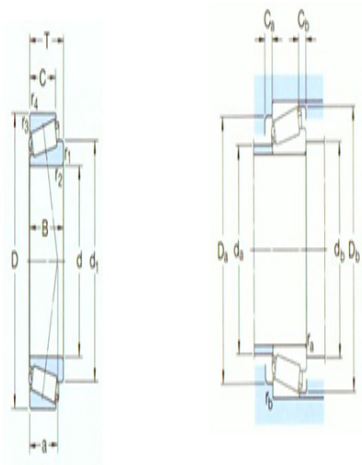

Dimensions are  
mm

d:	139.7
d <sub>1</sub> ~ :	187
B:	56.642
C:	44.45
r <sub>1,2</sub> the min:	3.5
r <sub>3,4</sub> the min:	3.3
a:	45

Shoulder gear and chamfer size  
mm

d <sub>a</sub> the max:	166
d <sub>b</sub> the min:	153
Da the min:	210
Da the max:	225
Db the min:	223
Ca the min:	9

Cb the min:	12.5
r <sub>a</sub> the max:	3
r <sub>b</sub> the max:	3

Calculation coefficient

e:	0.31
Y:	1.9
Yo:	1.1