



Model: C2215V

Basic size of
mm

d:	75
D:	130
B:	31

The basic rated load is
kN

trends C:	220
static state Co:	240
Fatigue load limit Pu:	29

Rated rotation speed is
r/min

Refer to the speed:	-
limit speed:	2200
quality:	1.65

model

Bearing cylindrical hole:	*C2215V
conical bore:	*C2215K V

Dimensions are
mm

d:	75
d ₂ ~ :	88.5
D1 ~ :	115
r _{1,2} the min:	1.5
s ₁ ¹⁾ ~ :	9.6
s ₂ ¹⁾ ~ :	5.3

Shoulder gear and chamfer size
mm

d _a the min:	84
d _a the max:	105
Da the min:	-
Da the max:	121
Ca ²⁾ the max:	-

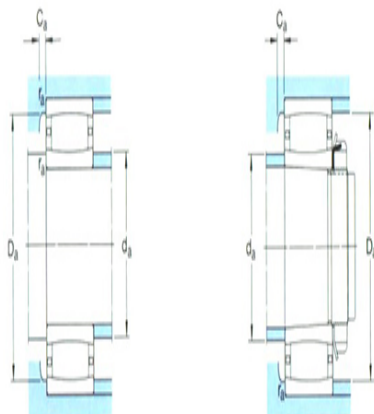
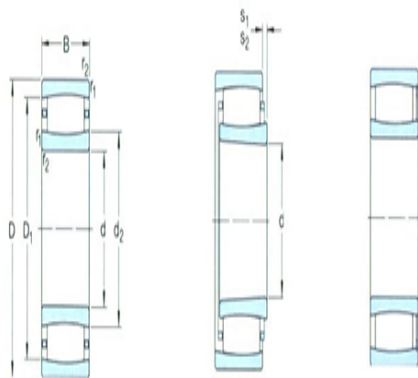

r_a the max:	1.5
----------------	-----

Calculation coefficient

k_1 :	0.099
---------	-------

k_2 :	0.127
---------	-------