



Model: C2217K

Basic size of
mm

d:	85
D:	150
B:	36

The basic rated load is
kN

trends C:	275
static state Co:	320
Fatigue load limit Pu:	36.5

Rated rotation speed is
r/min

Refer to the speed:	4300
limit speed:	5600
quality:	2.6

model

Bearing cylindrical hole:	*C2217
conical bore:	*C2217K

Dimensions are
mm

d:	85
d ₂ ~ :	104
D1 ~ :	133
r _{1,2} the min:	2
s ₁ ¹⁾ ~ :	7.1
s ₂ ¹⁾ ~ :	-

Shoulder gear and chamfer size
mm

d _a the min:	96
d _a the max:	110
Da the min:	125
Da the max:	139
Ca ²⁾ the max:	1.3
r _a the max:	2

Calculation coefficient

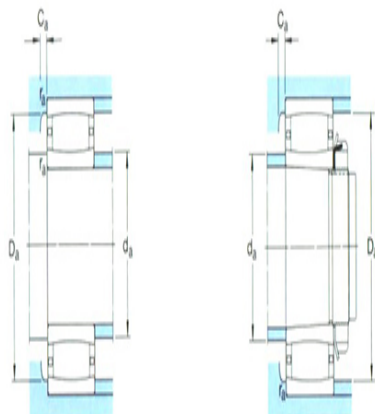
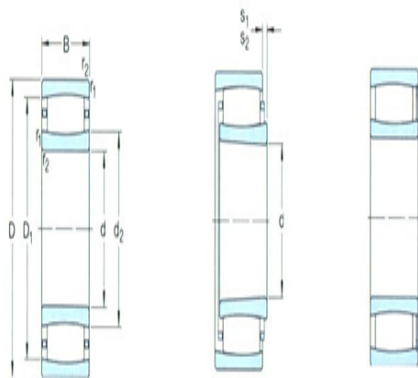

$k_1:$ 0.114

$k_2:$ 0.105