



Model: C3224

Basic size of
mm

d:	120
D:	215
B:	76

The basic rated load is
kN

trends C:	750
static state Co:	980
Fatigue load limit Pu:	98

Rated rotation speed is
r/min

Refer to the speed:	2400
limit speed:	3200
quality:	11.5

model

Bearing cylindrical hole:	*C3224
conical bore:	*C3224K

Dimensions are
mm

d:	120
d ₂ ~ :	149
D1 ~ :	190
r _{1,2} the min:	2.1
s ₁ ¹⁾ ~ :	17.1
s ₂ ¹⁾ ~ :	-

Shoulder gear and chamfer size
mm

d _a the min:	132
d _a the max:	160
Da the min:	180
Da the max:	203
Ca ²⁾ the max:	2.4
r _a the max:	2

Calculation coefficient

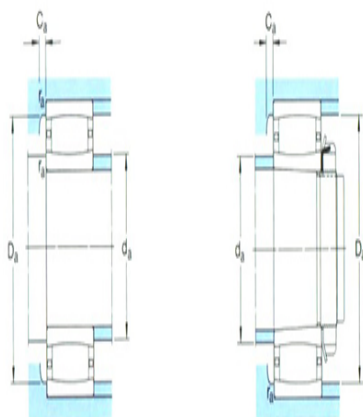
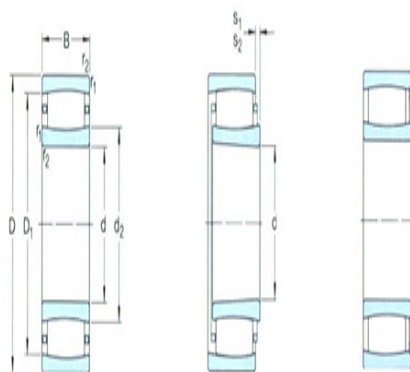

$k_1:$ 0.103

$k_2:$ 0.108