



Model: C4028K30V

Basic size of
 mm

d:	140
D:	210
B:	69

The basic rated load is
 kN

trends C:	750
static state Co:	1220
Fatigue load limit Pu:	118

Rated rotation speed is
 r/min

Refer to the speed:	-
limit speed:	800
quality:	8.55

model

Bearing cylindrical hole:	*C4028V
conical bore:	*C4028K30V

Dimensions are
 mm

d:	140
d ₂ ~ :	161
D1 ~ :	193
r _{1,2} the min:	2
s ₁ ¹⁾ ~ :	11.4
s ₂ ¹⁾ ~ :	5.9

Shoulder gear and chamfer size
 mm

d _a the min:	149
d _a the max:	175
Da the min:	-
Da the max:	201
Ca ²⁾ the max:	-

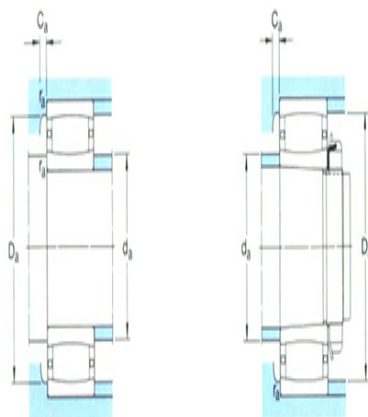
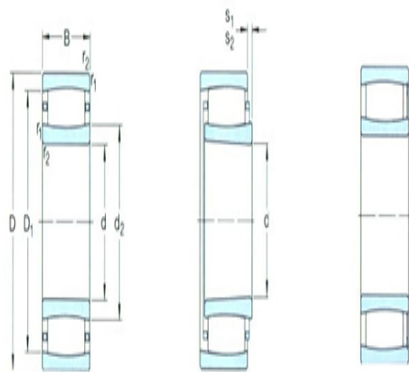

r_a the max:	2
----------------	---

Calculation coefficient

k_1 :	0.115
---------	-------

k_2 :	0.097
---------	-------