



Model: C4030K30V

Basic size of
mm

d:	150
D:	225
B:	75

The basic rated load is
kN

trends C:	780
static state Co:	1320
Fatigue load limit Pu:	125

Rated rotation speed is
r/min

Refer to the speed:	-
limit speed:	750
quality:	10.5

model

Bearing cylindrical hole:	*C4030V
conical bore:	*C4030K30V

Dimensions are
mm

d:	150
d ₂ ~ :	173
D1 ~ :	204
r _{1,2} the min:	2.1
s ₁ ¹⁾ ~ :	17.4
s ₂ ¹⁾ ~ :	10.6

Shoulder gear and chamfer size
mm

d _a the min:	161
d _a the max:	185
Da the min:	-
Da the max:	214
Ca ²⁾ the max:	-

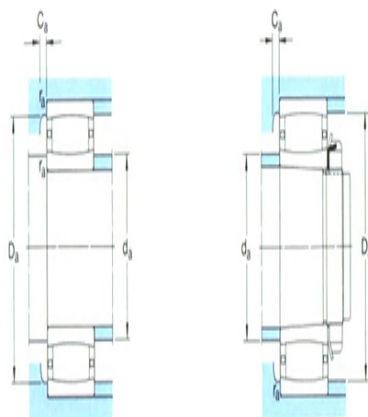
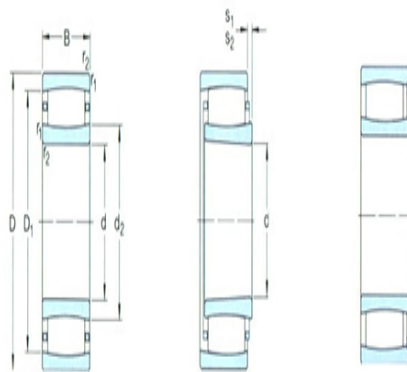

r_a the max:	2
----------------	---

Calculation coefficient

k_1 :	0.107
---------	-------

k_2 :	0.106
---------	-------