



## Model: C2230K

Basic size of  
mm

d:	150
D:	270
B:	73

The basic rated load is  
kN

trends C:	980
static state Co:	1220
Fatigue load limit Pu:	116

Rated rotation speed is  
r/min

Refer to the speed:	2400
limit speed:	3200
quality:	17.5

model

Bearing cylindrical hole:	*C2230
conical bore:	*C2230K

Dimensions are  
mm

d:	150
d <sub>2</sub> ~ :	177
D1 ~ :	236
r <sub>1,2</sub> the min:	3
s <sub>1</sub> <sup>1)</sup> ~ :	11.2
s <sub>2</sub> <sup>1)</sup> ~ :	-

Shoulder gear and chamfer size  
mm

d <sub>a</sub> the min:	164
d <sub>a</sub> the max:	200
Da the min:	215
Da the max:	256
Ca <sup>2)</sup> the max:	2.5
r <sub>a</sub> the max:	2.5

Calculation coefficient

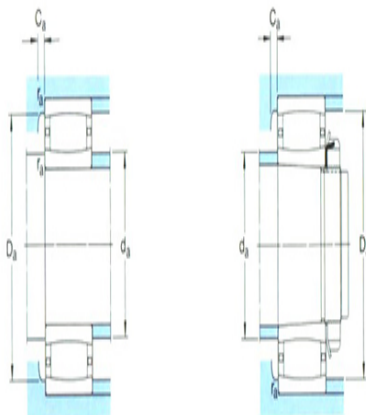
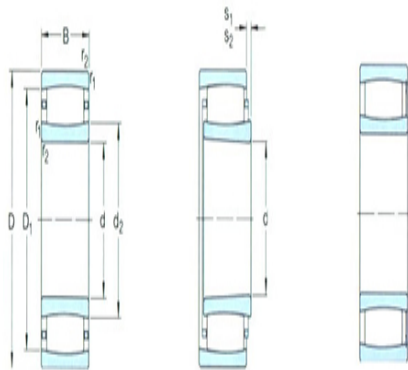

$k_1:$  0.119

$k_2:$  0.096