



Model: C3032K1

Basic size of
mm

d:	160
D:	240
B:	60

The basic rated load is
kN

trends C:	600
static state Co:	980
Fatigue load limit Pu:	93

Rated rotation speed is
r/min

Refer to the speed:	2200
limit speed:	3000
quality:	9.6

model

Bearing cylindrical hole:	*C30321)
conical bore:	*C3032K1)

Dimensions are
mm

d:	160
d ₂ ~ :	187
D1 ~ :	218
r _{1,2} the min:	2.1
s ₁ ¹⁾ ~ :	15
s ₂ ¹⁾ ~ :	-

Shoulder gear and chamfer size
mm

d _a the min:	171
d _a the max:	186
Da the min:	220
Da the max:	229
Ca ²⁾ the max:	5.1

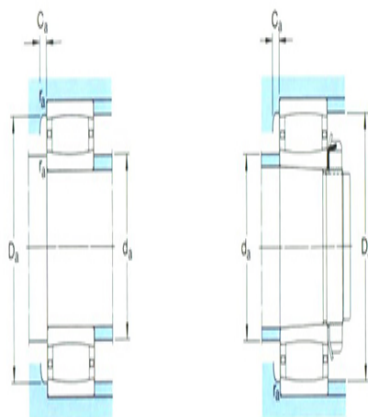
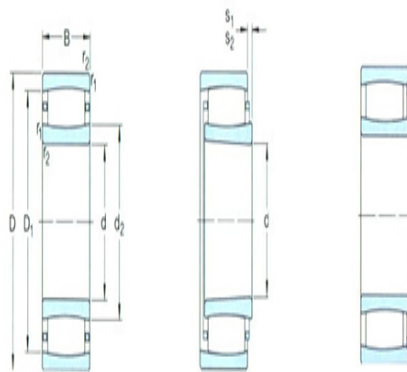

r_a the max:	2
----------------	---

Calculation coefficient

k_1 :	0.115
---------	-------

k_2 :	0.106
---------	-------