



Model: OH30/850HE

Basic size of
mm

d ₁ :	800
D :	1220
B :	272

The basic rated load is
kN

trends C :	11200
static state Co :	24000
Fatigue load limit Pu :	1370

Rated rotation speed is
r/min

Refer to the speed :	320
limit speed :	430
Mass bearing + tightening sleeve :	1050

model

bearing :	*C30/850KMB 1)
tapered adapter- sleeve :	OH30/850HE

Dimensions are
mm

d ₁ :	800
d ₂ ~ :	968
d ₃ :	980
D1 ~ :	1113
B ₁ :	380
B ₂ :	90
r _{1,2} the min :	115
s ₁ ¹⁾ ~ :	7.5
s ₂ ¹⁾ ~ :	27

Shoulder gear and chamfer size
mm

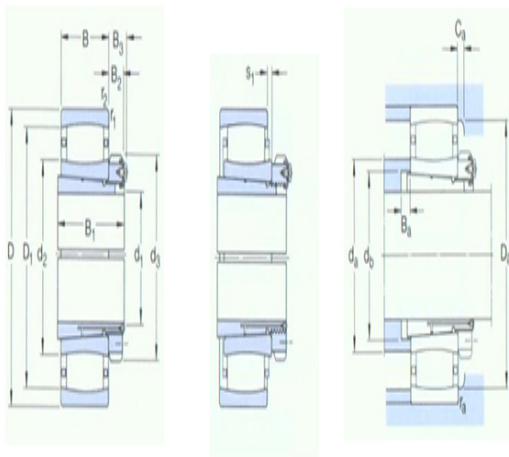

d_a the max:	965
d_b the min:	880
D_a the min:	1115
D_a the max:	1192
B_a the min:	28
$Ca^{2)}$ the min:	24.1
r_a the max:	6

Calculation coefficient

k_1 :	-
k_2 :	0.124