

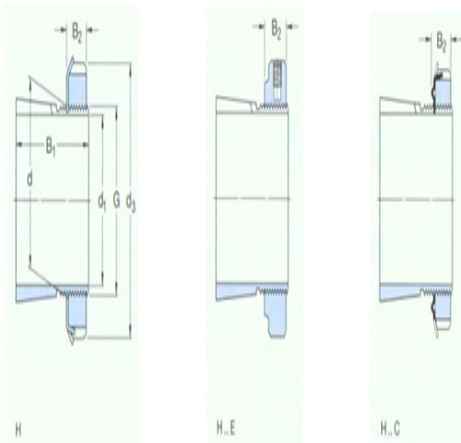

Model: H2306

size

d ₁ :	25
d:	30
d ₃ :	45
B ₁ :	38
B ₂ :	8
G:	M30×1.5
quality:	0.11



model

Tset ings with locking nuts and locking device:	H2306
locknut:	KM6
locking apparatus:	MB6
Applicable hydraulic pressure nuts:	-