

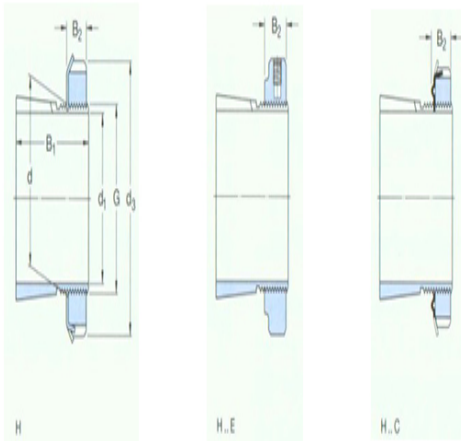

Model: H308C

size

d ₁ :	35
d:	40
d ₃ :	58
B ₁ :	36
B ₂ :	10.5
G:	M40×1.5
quality:	0.17



model

Tset ings with locking nuts and locking device:	H308C
locknut:	KM8
locking apparatus:	MB8C
Applicable hydraulic pressure nuts:	-