

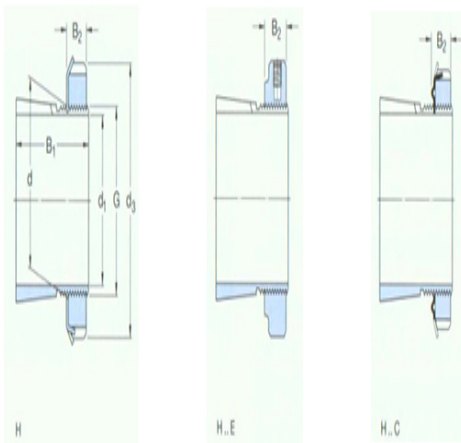

Model: H2308

size

d ₁ :	35
d:	40
d ₃ :	58
B ₁ :	46
B ₂ :	10
G:	M40×1.5
quality:	0.22



model

Tset ings with locking nuts and locking device:	H2308
locknut:	KM8
locking apparatus:	MB8
Applicable hydraulic pressure nuts:	-