

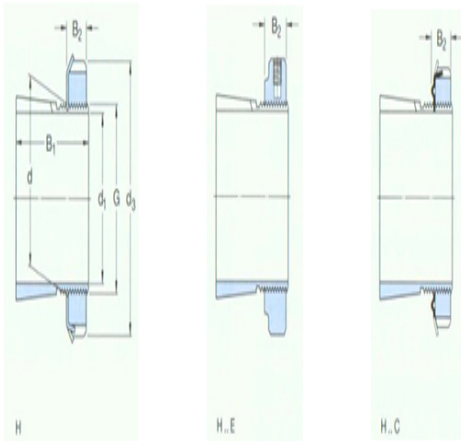

Model: H209

size

d ₁ :	40
d:	45
d ₃ :	65
B ₁ :	33
B ₂ :	11
G:	M45×1.5
quality:	0.21



model

Tset ings with locking nuts and locking device:	H209
locknut:	KM9
locking apparatus:	MB9
Applicable hydraulic pressure nuts:	-