

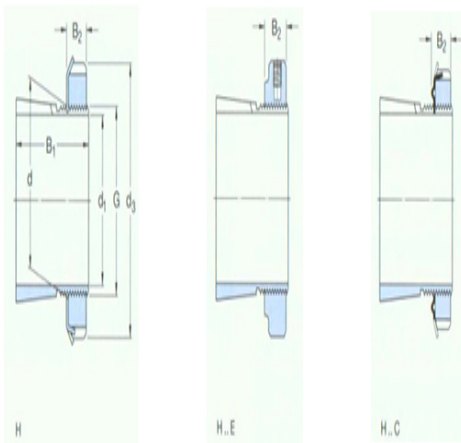

Model: H211

size

d ₁ :	50
d:	55
d ₃ :	75
B ₁ :	37
B ₂ :	12.5
G:	M55×2
quality:	0.28



model

Tset ings with locking nuts and locking device:	H211
locknut:	KM11
locking apparatus:	MB11
Applicable hydraulic pressure nuts:	HMV11
	E