

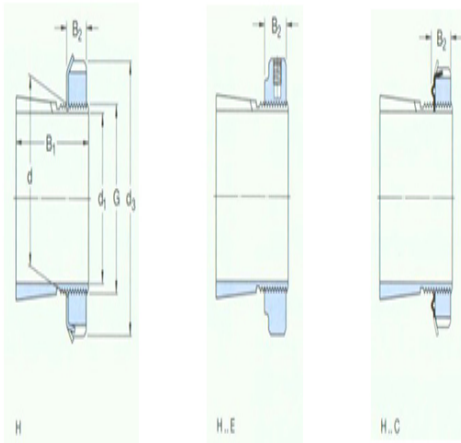

Model: H2313

size

d ₁ :	60
d:	65
d ₃ :	85
B ₁ :	65
B ₂ :	14
G:	M65×2
quality:	0.52



model

Tset ings with locking nuts and locking device:	H2313
locknut:	KM13
locking apparatus:	MB13
Applicable hydraulic pressure nuts:	HMV13 E