

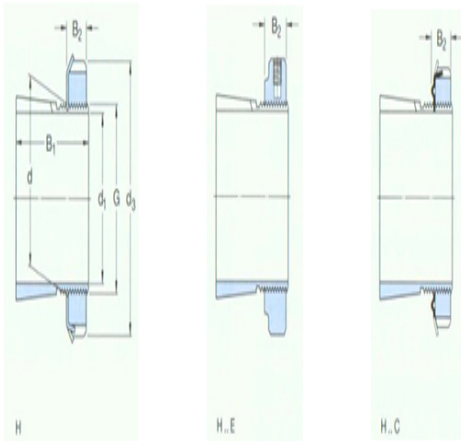

Model: H315

size

d ₁ :	65
d:	75
d ₃ :	98
B ₁ :	55
B ₂ :	15
G:	M75×2
quality:	0.78



model

Tset ings with locking nuts and locking device:	H315
locknut:	KM15
locking apparatus:	MB15
Applicable hydraulic pressure nuts:	HMV15 E