

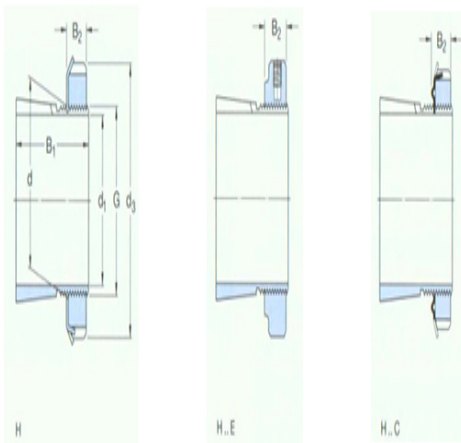

Model: H2316

size

d ₁ :	70
d:	80
d ₃ :	105
B ₁ :	78
B ₂ :	17
G:	M80×2
quality:	1.2



model

Tset ings with locking nuts and locking device:	H2316
locknut:	KM16
locking apparatus:	MB16
Applicable hydraulic pressure nuts:	HMV16 E