

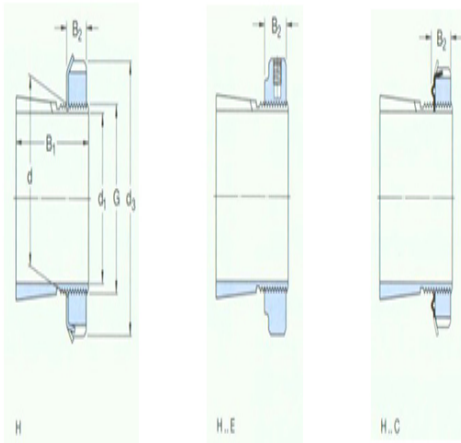

**Model: KM10**

size

d <sub>1</sub> :	45
d:	50
d <sub>3</sub> :	70
B <sub>1</sub> :	35
B <sub>2</sub> :	12
G:	M50×1.5
quality:	0.24



model

Tset ings with locking nuts and locking device:	H210
locknut:	KM10
locking apparatus:	MB10
Applicable hydraulic pressure nuts:	HMV10 E