

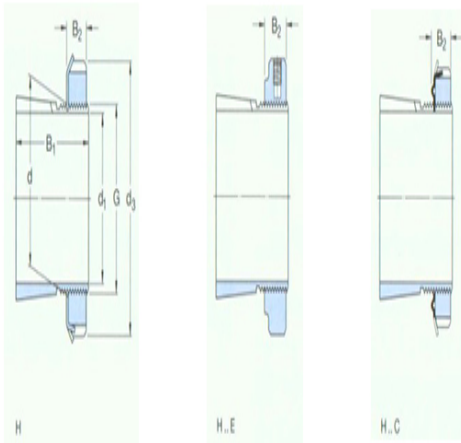

Model: KMFE11

size

d ₁ :	50
d:	55
d ₃ :	75
B ₁ :	45
B ₂ :	14
G:	M55×2
quality:	0.34



model

Tset ings with locking nuts and locking device:	H311E
locknut:	KMFE11
locking apparatus:	-
Applicable hydraulic pressure nuts:	HMV11 E