

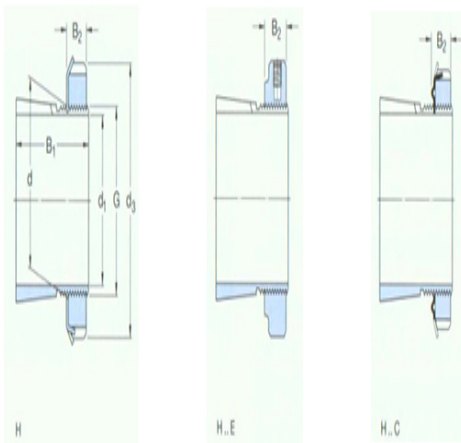

Model: KMFE12

size

d ₁ :	55
d:	60
d ₃ :	80
B ₁ :	47
B ₂ :	14
G:	M60×2
quality:	0.4



model

Tset ings with locking nuts and locking device:	H312E
locknut:	KMFE12
locking apparatus:	-
Applicable hydraulic pressure nuts:	HMV12 E