

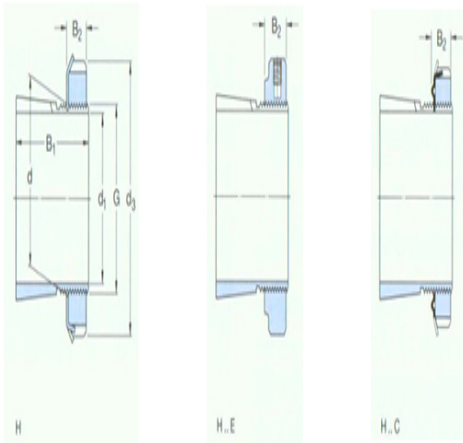

Model: KMFE13

size

d ₁ :	60
d:	65
d ₃ :	85
B ₁ :	50
B ₂ :	15
G:	M65×2
quality:	0.43



model

Tset ings with locking nuts and locking device:	H313E
locknut:	KMFE13
locking apparatus:	-
Applicable hydraulic pressure nuts:	HMV13 E