

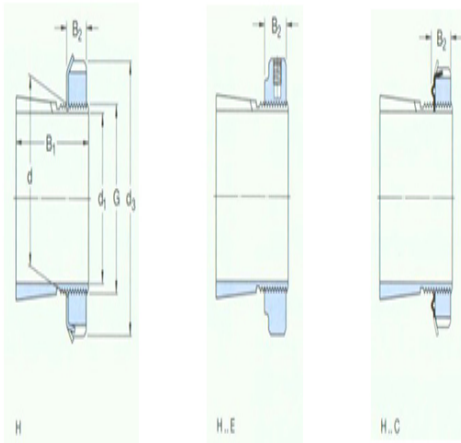

Model: KMFE15

size

d ₁ :	65
d:	75
d ₃ :	98
B ₁ :	55
B ₂ :	16
G:	M75×2
quality:	0.8



model

Tset ings with locking nuts and locking device:	H315E
locknut:	KMFE15
locking apparatus:	-
Applicable hydraulic pressure nuts:	HMV15 E