

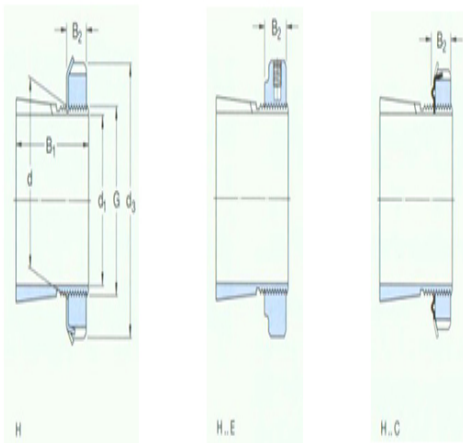

Model: MB7C

size

d ₁ :	30
d:	35
d ₃ :	52
B ₁ :	35
B ₂ :	9.5
G:	M35×1.5
quality:	0.14



model

Tset ings with locking nuts and locking device:	H307C
locknut:	KM7
locking apparatus:	MB7C
Applicable hydraulic pressure nuts:	-