

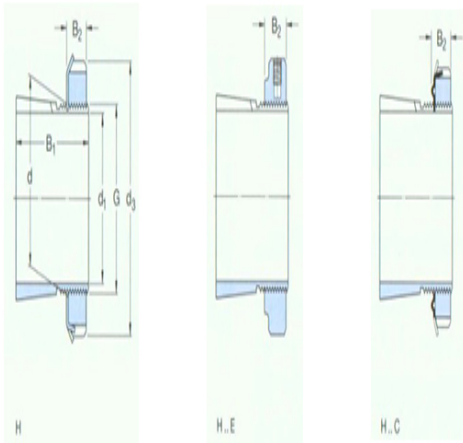

Model: MB12

size

d ₁ :	55
d:	60
d ₃ :	80
B ₁ :	38
B ₂ :	13
G:	M60×2
quality:	0.31



model

Tset ings with locking nuts and locking device:	H212
locknut:	KM12
locking apparatus:	MB12
Applicable hydraulic pressure nuts:	HMV12 E