

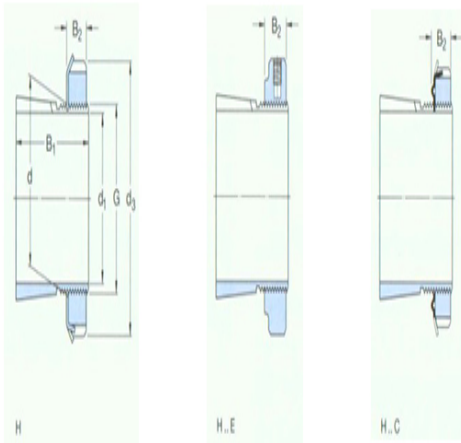

Model: MB14

size

d ₁ :	60
d:	70
d ₃ :	92
B ₁ :	52
B ₂ :	14
G:	M70×2
quality:	0.67



model

Tset ings with locking nuts and locking device:	H314
locknut:	KM14
locking apparatus:	MB14
Applicable hydraulic pressure nuts:	HMV14 E