

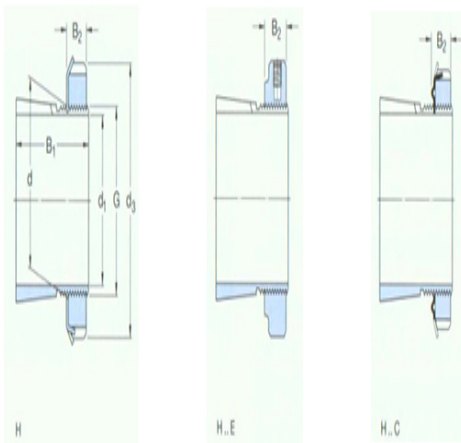

**Model: MB15**

size

d <sub>1</sub> :	65
d:	75
d <sub>3</sub> :	98
B <sub>1</sub> :	55
B <sub>2</sub> :	15
G:	M75×2
quality:	0.78



model

Tset ings with locking nuts and locking device:	H315
locknut:	KM15
locking apparatus:	MB15
Applicable hydraulic pressure nuts:	HMV15 E