

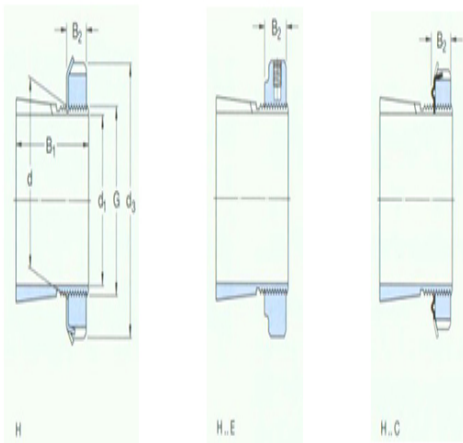

**Model: HMV12E**

size

d <sub>1</sub> :	55
d:	60
d <sub>3</sub> :	80
B <sub>1</sub> :	47
B <sub>2</sub> :	14
G:	M60×2
quality:	0.4



model

Tset ings with locking nuts and locking device:	H312E
locknut:	KMFE12
locking apparatus:	-
Applicable hydraulic pressure nuts:	HMV12 E