

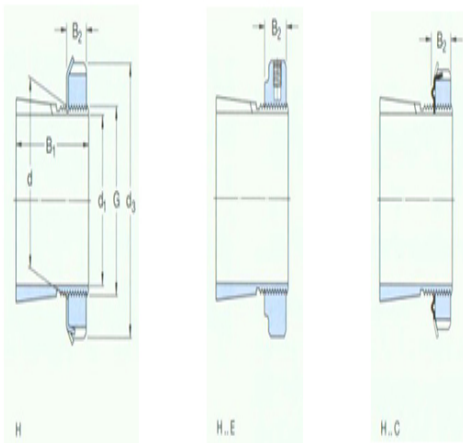

Model: HMV13E

size

d ₁ :	60
d:	65
d ₃ :	85
B ₁ :	40
B ₂ :	14
G:	M65×2
quality:	0.36



model

Tset ings with locking nuts and locking device:	H213
locknut:	KM13
locking apparatus:	MB13
Applicable hydraulic pressure nuts:	HMV13 E