

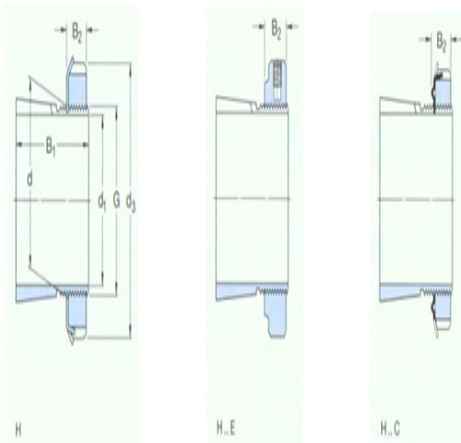

Model: HMV14E

size

d ₁ :	60
d:	70
d ₃ :	92
B ₁ :	52
B ₂ :	15
G:	M70×2
quality:	0.67



model

Tset ings with locking nuts and locking device:	H314E
locknut:	KMFE14
locking apparatus:	-
Applicable hydraulic pressure nuts:	HMV14 E