

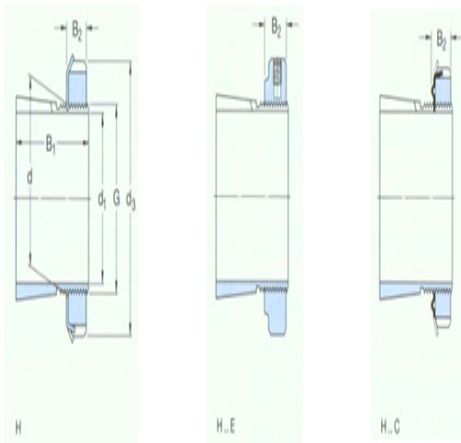

**Model: HMV14E**

size

d <sub>1</sub> :	60
d:	70
d <sub>3</sub> :	92
B <sub>1</sub> :	68
B <sub>2</sub> :	14
G:	M70×2
quality:	0.88



model

Tset ings with locking nuts and locking device:	H2314
locknut:	KM14
locking apparatus:	MB14
Applicable hydraulic pressure nuts:	HMV14 E