

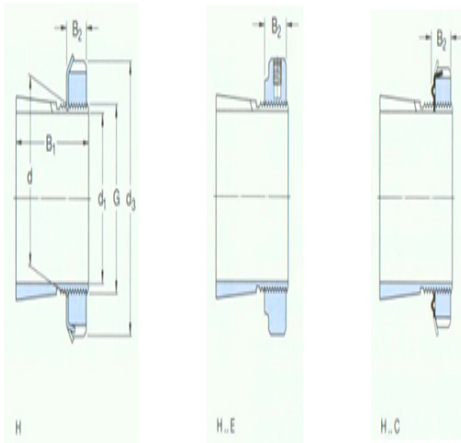

**Model: HMV16E**

size

d <sub>1</sub> :	70
d:	80
d <sub>3</sub> :	105
B <sub>1</sub> :	59
B <sub>2</sub> :	17
G:	M80×2
quality:	0.95



model

Tset ings with locking nuts and locking device:	H316
locknut:	KM16
locking apparatus:	MB16
Applicable hydraulic pressure nuts:	HMV16 E