

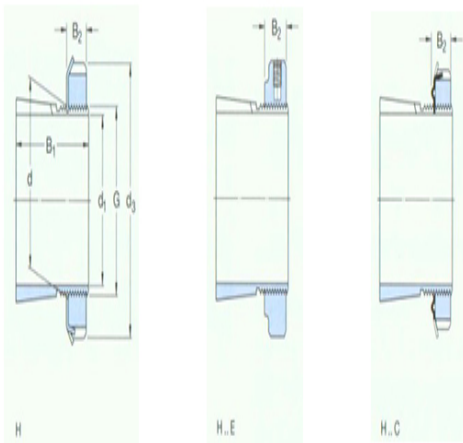

Model: HMV17E

size

d ₁ :	75
d:	85
d ₃ :	110
B ₁ :	50
B ₂ :	18
G:	M85×2
quality:	0.94



model

Tset ings with locking nuts and locking device:	H217
locknut:	KM17
locking apparatus:	MB17
Applicable hydraulic pressure nuts:	HMV17 E