

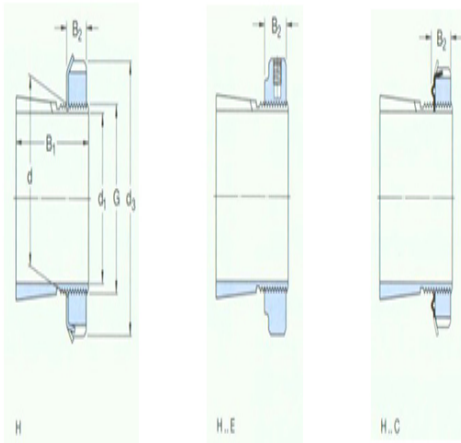

**Model: HMV17E**

size

d <sub>1</sub> :	75
d:	85
d <sub>3</sub> :	110
B <sub>1</sub> :	63
B <sub>2</sub> :	18
G:	M85×2
quality:	1.1



model

Tset ings with locking nuts and locking device:	H317
locknut:	KM17
locking apparatus:	MB17
Applicable hydraulic pressure nuts:	HMV17 E