

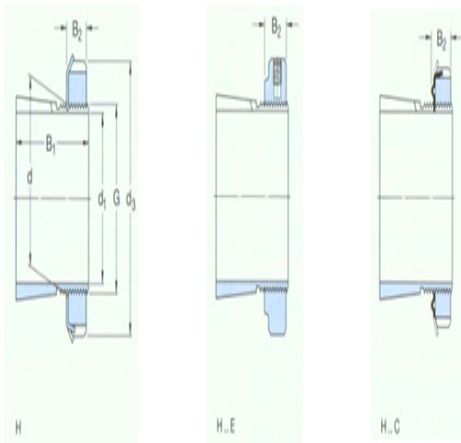

Model: HMV17E

size

d ₁ :	75
d:	85
d ₃ :	110
B ₁ :	82
B ₂ :	18
G:	M85×2
quality:	1.35



model

Tset ings with locking nuts and locking device:	H2317
locknut:	KM17
locking apparatus:	MB17
Applicable hydraulic pressure nuts:	HMV17 E