

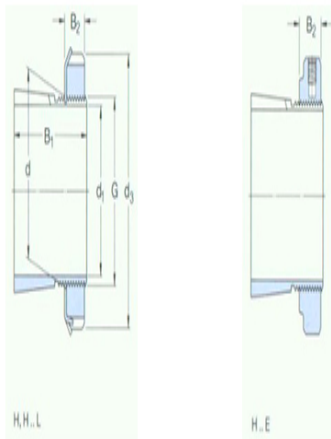

Model: H220

size

d ₁ :	90
d:	100
d ₃ :	130
B ₁ :	58
B ₂ :	20
G:	M100× 2
quality:	1.4



model

Tset ings with locking nuts and locking device:	H220
locknut:	KM20
locking apparatus:	MB20
Applicable hydraulic pressure nuts:	HMV20 E