

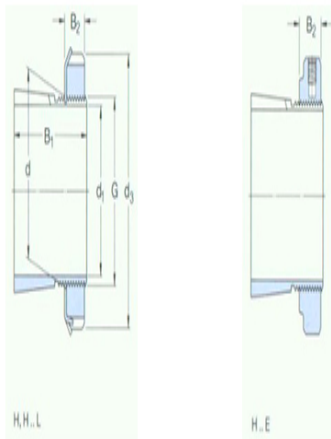

Model: H3140

size

d ₁ :	180
d:	200
d ₃ :	250
B ₁ :	150
B ₂ :	31.5
G:	M200× 3
quality:	12



model

Tset ings with locking nuts and locking device:	H3140
locknut:	KM40
locking apparatus:	MB40
Applicable hydraulic pressure nuts:	HMV40 E