

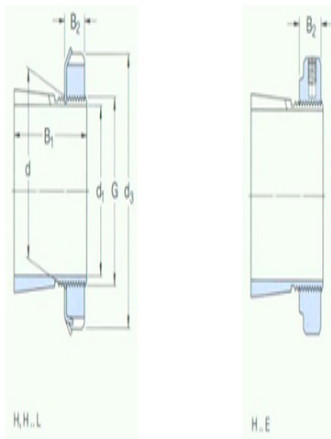

Model: MB24

size

d ₁ :	110
d:	120
d ₃ :	155
B ₁ :	112
B ₂ :	22
G:	M120× 2
quality:	3



model

Tset ings with locking nuts and locking device:	H2324
locknut:	KM24
locking apparatus:	MB24
Applicable hydraulic pressure nuts:	HMV24 E