

Model: SBR50X470

Param

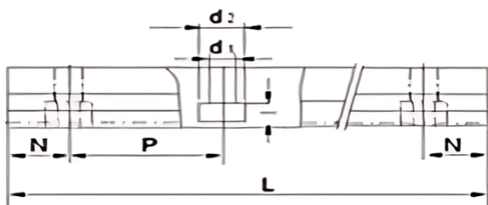
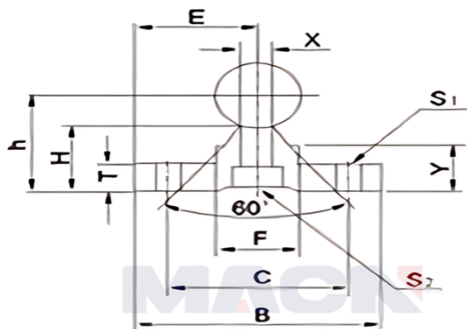
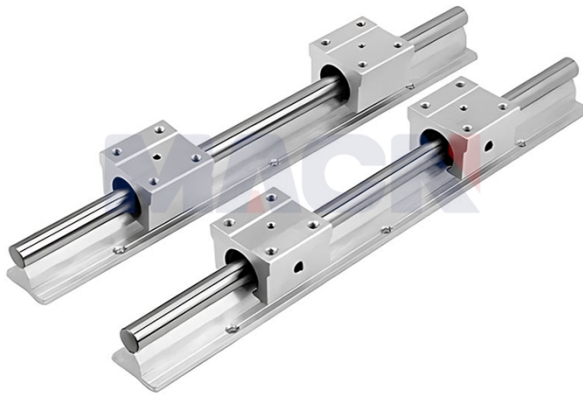

model:	SBR50X470
Axial diameter size:	φ50
E:	47.5
h:	62
B:	95
H:	38.8
T:	11
F:	45
X:	20
Y:	21
C:	70
S1:	φ11
S2:	11×17.5×10.8
Guide rail support standard length L:	340
N:	35
P:	200
Maximum length of the guide rail support:	2070
weight:	5.26