

Model: UCP207-22

Shaft Dia.

| | |
|----------|------|
| d (in.): | 13/8 |
| d (mm): | |

Dimensions(mm)(inch)

| | |
|-----|--------|
| H: | 1.8740 |
| L: | 6.5748 |
| J: | 5.0000 |
| A: | 1.8898 |
| N: | 0.6693 |
| N1: | 0.8268 |
| H1: | 0.7087 |
| H2: | 3.6614 |
| S: | 0.6890 |
| B: | 1.6890 |

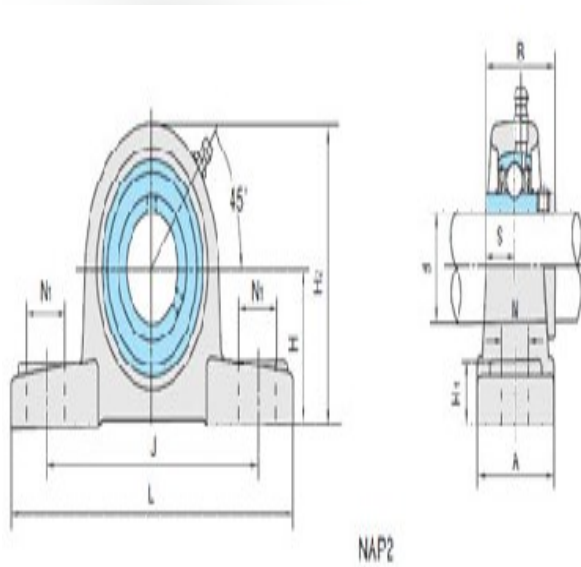

Unit No.

| | |
|-----------|-----------|
| Unit No.: | UCP207-22 |
|-----------|-----------|

Bolt Used (mm) (in.)

| | |
|-----------------------|------|
| Bolt Used (mm) (in.): | 9/16 |
|-----------------------|------|

Bearing No.

| | |
|--------------|----------|
| Bearing No.: | UC207-22 |
|--------------|----------|

Housing No.

| | |
|--------------|--|
| Housing No.: | |
|--------------|--|

Weight(kg)(lb)

| | |
|-----------------|--|
| Weight(kg)(lb): | |
|-----------------|--|