

Model: SER206-19

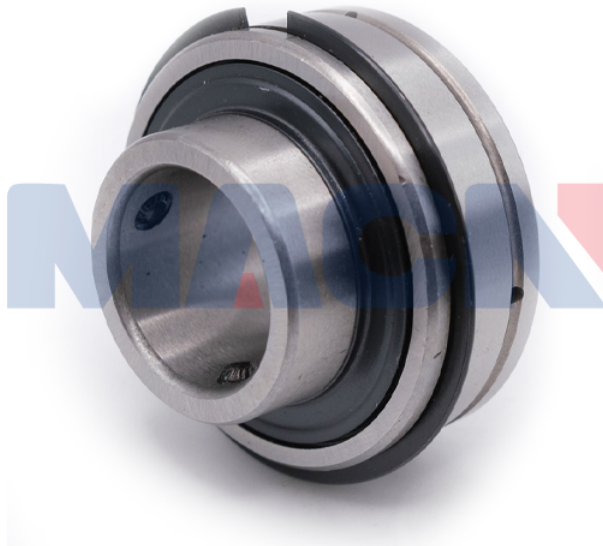

Shaft Dia.

d (in.):	13/16
d (mm):	

Dimensions(mm)(inch)

D:	2.4409
Bi:	1.5000
Be:	0.8740
n:	0.6260
m:	0.8740
E:	0.6701
a:	0.0650
h:	0.2205
R:	0.2331
J:	0.1291
P:	2.6654
G:	0.2205
ds:	

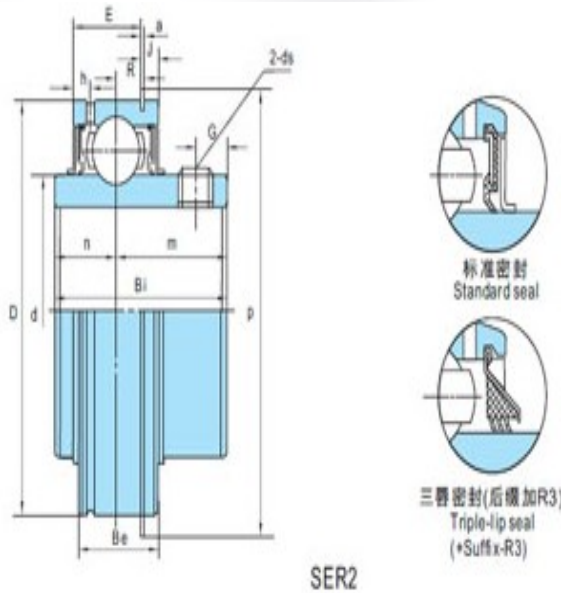

Rated load (KN)

Cr:	1530
Cor:	1020

Bearing No.

Bearing No.:	SER206-19
--------------	-----------

Weight(kg)(lb)

Weight(kg)(lb):	
-----------------	--