

Model: SER205-14

Shaft Dia.

d (in.):	7/8
d (mm):	

Dimensions(mm)(inch)

D:	2.0472
Bi:	1.3740
Be:	0.7520
n:	0.5158
m:	0.8583
E:	0.6020
a:	0.0421
h:	0.2047
R:	0.2260
J:	0.0969
P:	2.2795
G:	0.2205
ds:	

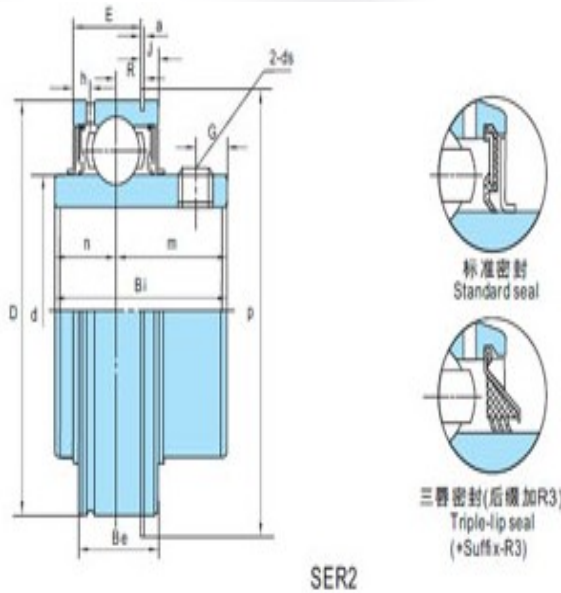
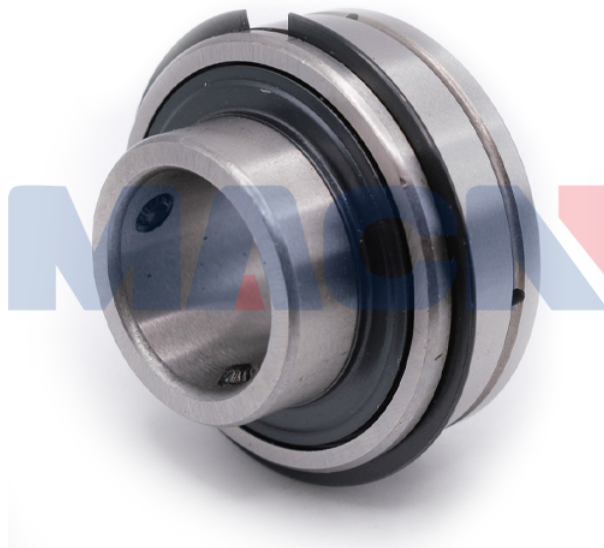

Rated load (KN)

Cr:	1100
Cor:	710

Bearing No.

Bearing No.:	SER205-14
--------------	-----------

Weight(kg)(lb)

Weight(kg)(lb):	
-----------------	--