

Model: BLP207-20

Shaft Dia.

d (in.):	1 1/4
d (mm):	

Dimensions(mm)(inch)

H:	1.8740
L:	6.4961
J:	5.0000
A:	1.3780
N:	0.5512
N1:	0.8268
H1:	0.6299
H2:	3.6614
S:	0.3346
B:	1.2598

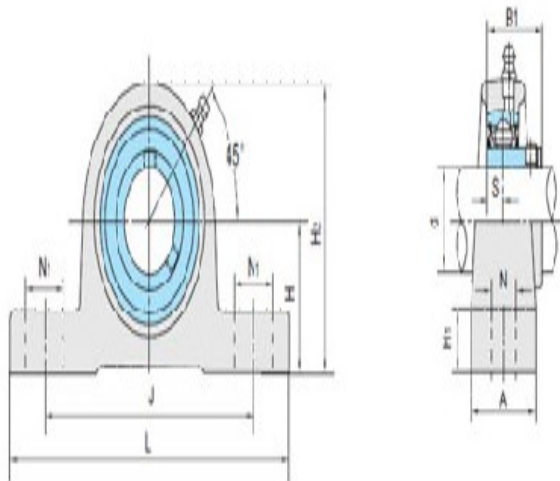

BLP2

Unit No.

Unit No.:	BLP207-20
-----------	-----------

Bolt Used (mm) (in.)

Bolt Used (mm) (in.):	1/2
-----------------------	-----

Bearing No.

Bearing No.:	SB207-20A
--------------	-----------

Housing No.

Housing No.:	
--------------	--

Weight(kg)(lb)

Weight(kg)(lb):	
-----------------	--