

Model: BLP205-14

Shaft Dia.

d (in.):	7/8
d (mm):	

Dimensions(mm)(inch)

H:	1.4370
L:	5.1181
J:	3.9370
A:	1.1417
N:	0.4528
N1:	0.6299
H1:	0.5118
H2:	2.7953
S:	0.2953
B:	1.0630

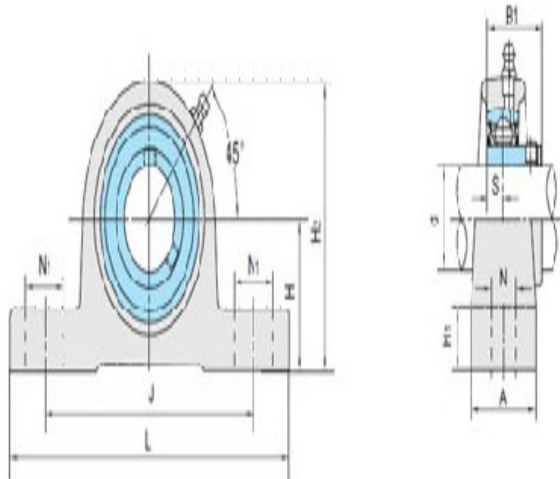

BLP2

Unit No.

Unit No.:	BLP205-14
-----------	-----------

Bolt Used (mm) (in.)

Bolt Used (mm) (in.):	3/8
-----------------------	-----

Bearing No.

Bearing No.:	SB205-14A
--------------	-----------

Housing No.

Housing No.:	
--------------	--

Weight(kg)(lb)

Weight(kg)(lb):	
-----------------	--