

**Model: BLP202-10**

Shaft Dia.

d (in.):	5/8
d (mm):	

Dimensions(mm)(inch)

H:	1.1890
L:	4.4882
J:	3.4252
A:	0.9842
N:	0.4528
N1:	0.6299
H1:	0.4724
H2:	2.2441
S:	0.2362
B:	0.8661

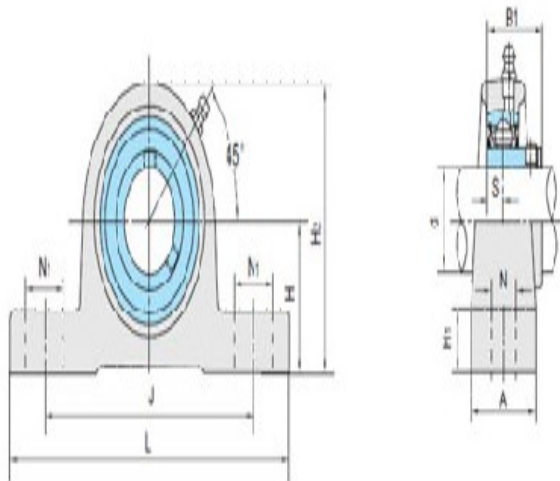

BLP2

Unit No.

Unit No.:	BLP202-10
-----------	-----------

Bolt Used (mm) (in.)

Bolt Used (mm) (in.):	3/8
-----------------------	-----

Bearing No.

Bearing No.:	SB202-10A
--------------	-----------

Housing No.

Housing No.:	
--------------	--

Weight(kg)(lb)

Weight(kg)(lb):	
-----------------	--