

Model: UCF310-30

Shaft Dia.

d (in.):	17/8
d (mm):	

Dimensions(mm)(inch)

L:	6.8898
J:	5.1968
A2:	1.1024
A1:	0.7480
A:	1.8898
N:	0.9055
E:	2.6378
S:	0.8661

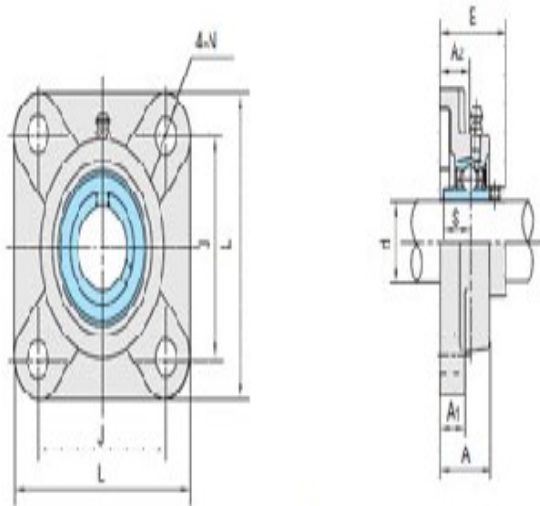

UCF3

Unit No.

Unit No.:	UCF310-30
-----------	-----------

Bolt Used (mm) (in.)

Bolt Used (mm) (in.):	3/4
-----------------------	-----

Bearing No.

Bearing No.:	UC310-30
--------------	----------

Housing No.

Housing No.:	
--------------	--

Weight(kg)(lb)

Weight(kg)(lb):	
-----------------	--