



Model: UCF307-22

Shaft Dia.

d (in.):	13/8
d (mm):	

Dimensions(mm)(inch)

L:	5.3150
J:	3.9370
A2:	0.7874
A1:	0.6299
A:	1.4173
N:	0.7480
E:	1.9291
S:	0.7480

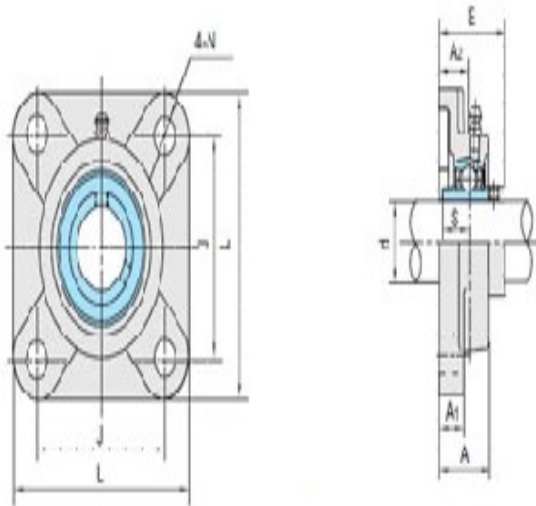

UCF3

Unit No.

Unit No.:	UCF307-22
-----------	-----------

Bolt Used (mm) (in.)

Bolt Used (mm) (in.):	5/8
-----------------------	-----

Bearing No.

Bearing No.:	UC307-22
--------------	----------

Housing No.

Housing No.:	
--------------	--

Weight(kg)(lb)

Weight(kg)(lb):	
-----------------	--