



Model: UCF306-17

Shaft Dia.

d (in.):	11/16
d (mm):	

Dimensions(mm)(inch)

L:	4.9212
J:	3.7402
A2:	0.7087
A1:	0.5906
A:	1.2598
N:	0.6299
E:	1.7323
S:	0.6693

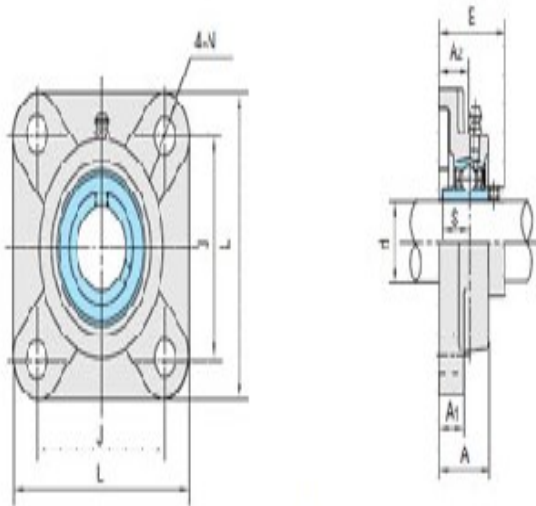

UCF3

Unit No.

Unit No.:	UCF306-17
-----------	-----------

Bolt Used (mm) (in.)

Bolt Used (mm) (in.):	9/16
-----------------------	------

Bearing No.

Bearing No.:	UC306-17
--------------	----------

Housing No.

Housing No.:	
--------------	--

Weight(kg)(lb)

Weight(kg)(lb):	
-----------------	--