

**Model: UKF210+H2310**

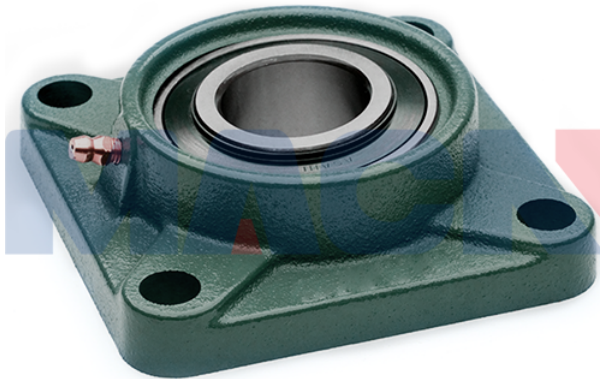

**Shaft Dia.**

d (in.):	
d (mm):	45

**Dimensions(mm)(inch)**

L:	143
J:	111
A2:	22
A1:	16
A:	40
N:	16
E:	49.5
S1:	27.5

Unit No. Unit No. Unit No.

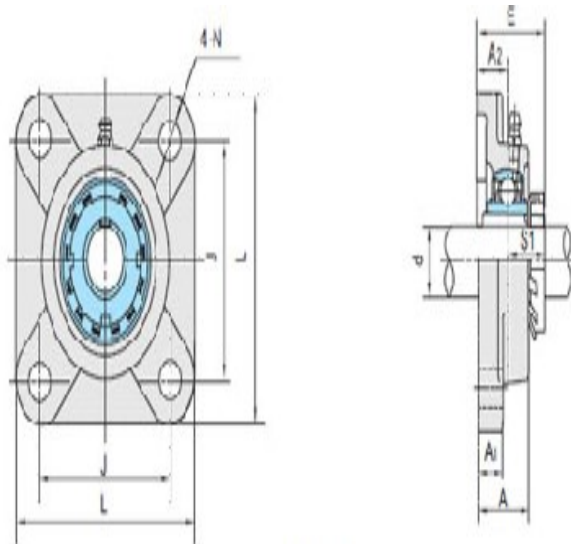

UKF2+H

**Unit No.**

Unit No.:	UKF210+H2310
	0

**Bolt Used (mm) (in.)**

Bolt Used (mm) (in.):	M14
-----------------------	-----

**Bearing No.**

Bearing No.:	UK210
--------------	-------

**Housing No.**

Housing No.:	F210
--------------	------

**Adapter Used.**

Adapter Used.:	H2310
----------------	-------

**Weight(kg)(lb)**

Weight(kg)(lb):	2.57
-----------------	------