

Model: UKF208+H2308

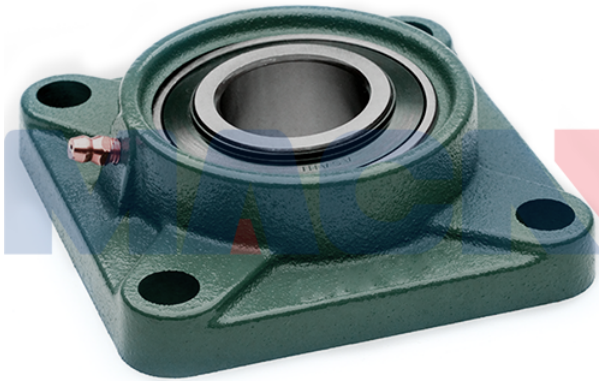

Shaft Dia.

d (in.):	
d (mm):	35

Dimensions(mm)(inch)

L:	130
J:	102
A2:	21
A1:	15
A:	36
N:	16
E:	45.5
S1:	24.5

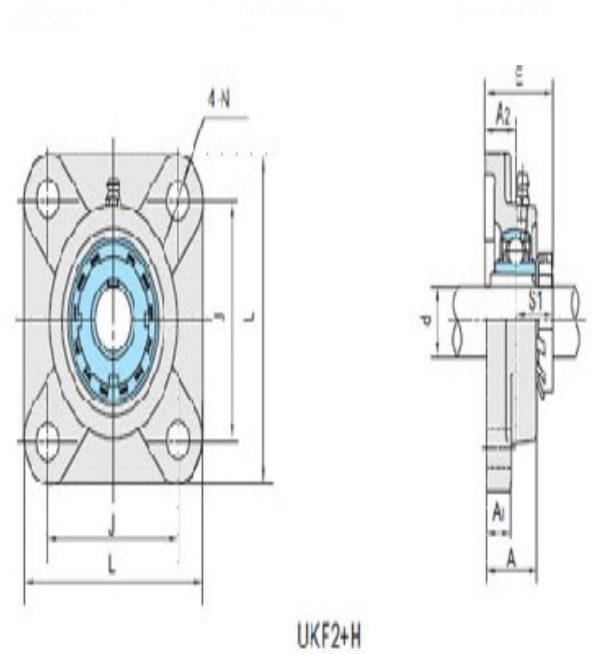

Unit No.

Unit No.:	UKF208+H2308
	8

Bolt Used (mm) (in.)

Bolt Used (mm)	M14
(in.):	

Bearing No.

Bearing No.:	UK208
--------------	-------

Housing No.

Housing No.:	F208
--------------	------

Adapter Used.

Adapter Used.:	H2308
----------------	-------

Weight(kg)(lb)

Weight(kg)(lb):	1.92
-----------------	------