

Model: UKF206+H2306

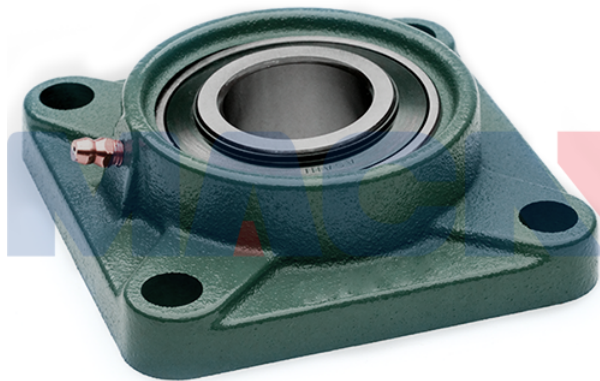

Shaft Dia.

d (in.):	
d (mm):	25

Dimensions(mm)(inch)

L:	108
J:	83
A2:	18
A1:	13
A:	31
N:	12
E:	39.0
S1:	21.0

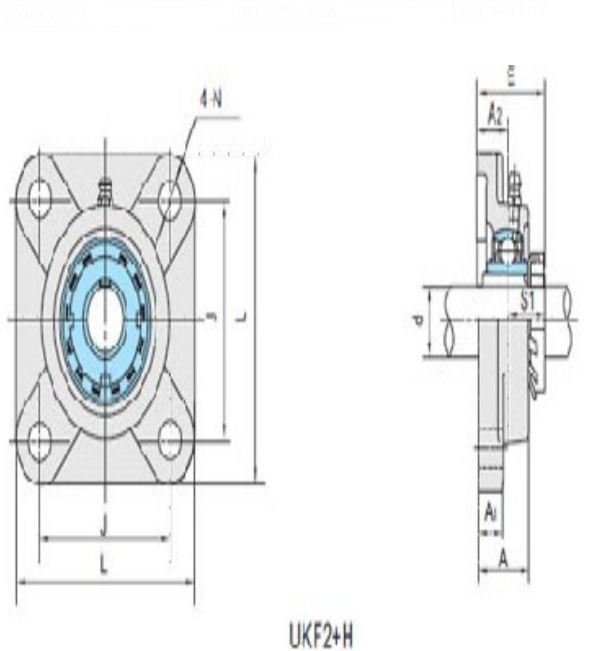

Unit No.

Unit No.:	UKF206+H2306
	6

Bolt Used (mm) (in.)

Bolt Used (mm)	M10
(in.):	

Bearing No.

Bearing No.:	UK206
--------------	-------

Housing No.

Housing No.:	F206
--------------	------

Adapter Used.

Adapter Used.:	H2306
----------------	-------

Weight(kg)(lb)

Weight(kg)(lb):	1.21
-----------------	------